

ANAN-7000DLE MKII

(Please note this Model does not incorporate the embedded PC)



The ANAN-7000DLE MKII HF & 6M 100W SDR Transceiver meets and exceeds the requirements of even the most discerning Amateur Radio Operator, it is based on the work of the OpenHPSDR community.

DESIGN TEAM

Phil Harman, VK6PH

Hardware Design, Ethernet Protocol for the OpenHPSDR/ANAN SDRs, FPGA code, KISS Console, VNA Software.

Doug Wigley, W5WC

OpenHPSDR PowerSDR developer and Custodian.

Dr. Warren C Pratt, NR0V

WDSP DSP Engine, PureSignal (Predistortion Algorithm), Minimized Latency Filtering, Noise mitigation Algorithms.

Kjell Karlsen, LA2NI

RF Driver Amplifier and other Hardware inputs.

Abhishek Prakash

Orion MKII and overall Hardware design.

Dr. Joe Martin, K5SO

Orion MKII FPGA code, Diversity and Radio Astronomy code.

John Melton, G0ORX/N6LYT

Developer of the PiHPSDR, Android, QTHPSDR and GHPSDR Applications.

Adam Farson, AB40J/VA7OJ

Detailed Hardware Testing and Analysis.

Richard Koch, N1GP

Firmware Development.

CUTTING EDGE FEATURES:

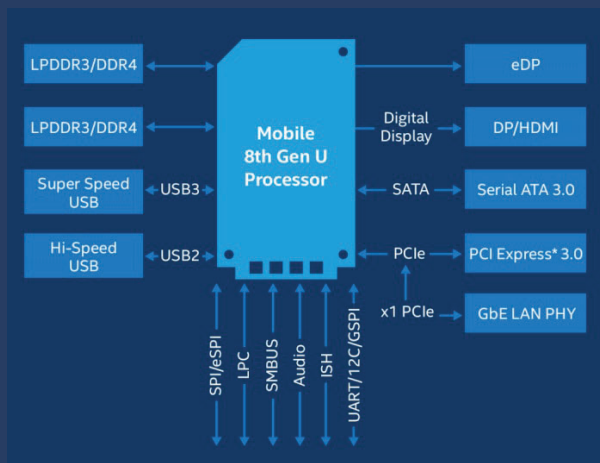

The ANAN-7000DLE MKII Monoblock SDR incorporates an optional Intel 8th Generation i5/i7 Core Computer. The Radio with the PC option has the software client preloaded and configured, hence making the unit completely independent and plug & play!

Unlike other Software defined radios which incorporate embedded processing with limited capabilities and no upgrade path, the 7000DLE MKII uses a powerful Intel 8th Generation quad core SoC and Windows, this allows for Digital transmission such as FT8 and other digital modes out of the box.



The Combination of 8th Generation Intel core hardware along with Windows 10 OS makes for a potent and widely compatible processing system.

Noise Mitigation: The new Spectral Noise Blanker uses a priori knowledge of speech and noise, specifically, statistical models of speech and noise, to produce superior signal-to-noise ratios and vibrant sound.

Minimized Latency: Filtering contributes most of the latency in SDR processing. There are two reasons: (1) large sets of samples, "buffers," are normally collected before executing the filter so that efficient FFT algorithms can be used, and (2) sharp "brick-wall" linear-phase filters inherently have a long latency, no matter how implemented. Both these issues have been addressed and conquered in the ANAN-7000DLE MKII. Small "buffers," requiring little collection time, can now be used even with very sharp "brick-wall" filters. In addition, the option of using very low-latency "minimum-phase" filters is provided. In almost all situations, laboratory and on-air testing have demonstrated no discernible difference in performance between linear-phase and minimum-phase filters. With filters as sharp as you desire, sub-20ms receive latencies are now available, comparable to the best of conventional DSP radios and much better than competing SDRs!

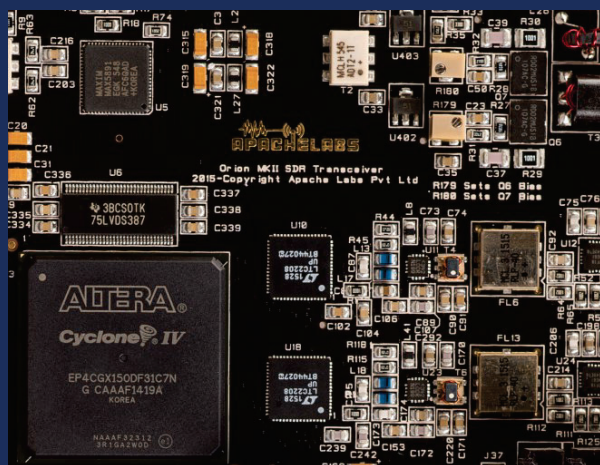

The ANAN-7000DLE MKII includes two phase synchronous front ADCs to enable Diversity reception and other advanced applications, the transmit chain is designed keeping in mind PureSignal (Predistortion).

The ANAN-7000DLE MKII provides protection against high SWR, there are onboard sensors to detect Voltage, Current and chassis temperature.

PURESIGNAL PREDISTORTION

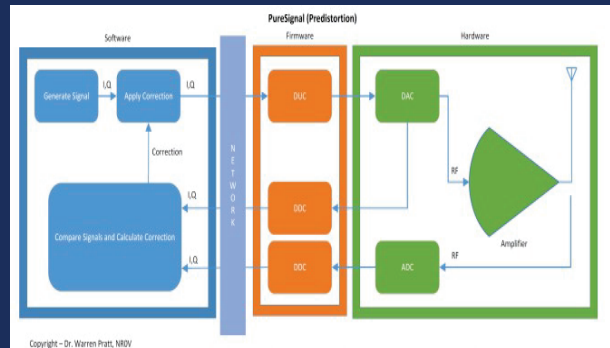

There is no truly Linear RF amplifier, the non-linearity in an amplifier shows up as Inter Modular distortion within and outside the transmitted bandwidth, there are challenges to reducing IMD which are not trivial, hence, most manufacturers either do not quote IMD values in their specifications or use an inefficient Class A option at much lower than rated power output to slightly reduce IMD.

The ANAN-7000DLE MKII has been built from scratch keeping in mind PureSignal (Predistortion), it achieves an astounding -66dB IMD (below PEP) on 20M at full 100W output, this is at least 25 to 30dB or approximately a 1000 times lower distortion than a "Class A" capable flagship transceiver.

An ultra-rugged LDMOS driver and a rugged MOSFET amplifier completely

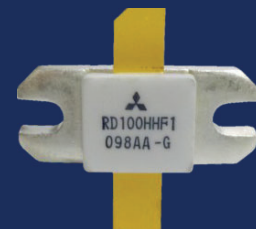

Redesigned for adaptive Predistortion achieves excellent IMD figures, no other brand Transceiver can match the ANAN-7000DLE MKII Transmit IMD.

The ANAN-7000DLE MKII uses the universally accepted 13.8v DC supply standard for the internal PC and the Radio, hence, making it extremely adaptable to field use.

NETWORKED SDR:

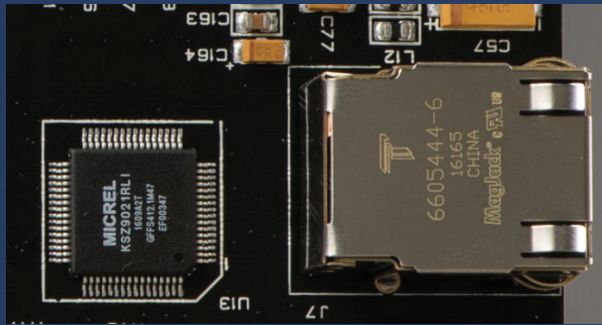

All ANAN transceivers use a Gigabit Ethernet interface to connect to the outside world, this means no drivers, huge bandwidth, better noise isolation from the PC and networked radios with remote access and much more. The PC to SDR cable can be longer or you can go wireless and connect the radio to your Wi-Fi and use the radio from anywhere in your home or office.

WITH APPROPRIATE SOFTWARE AND ANTENNAS OUR SDRS CAN BE USED FOR :

- Phil Harman, VK6PH's VNA Application
- Alex, VE3NEA's VNA Application
- Polarization diversity operations (using both ADCs) to remove Faraday Rotation effects and to remove polarization misalignment effects during Rx
- Spatial diversity operations to mitigate/reduce signal fading compared with single antenna operations

THE ANAN SDRs WILL WORK ON A MULTITUDE OF SOFTWARE PLATFORMS SUCH AS :

- The OpenHPSDR flavours of PowerSDR
- cuSDR
- Kiss Konsole
- GNURADIO-OpenHPSDR
- John Melton's (G0ORX/N6LYT) PiHPSDR, Linux LinHPSDR (Supports Seven High Performance Independent Receivers) & Android application for The OpenHPSDR hardware
- GHPSDR3, GHPSDR3-QT



Back Panel IOs

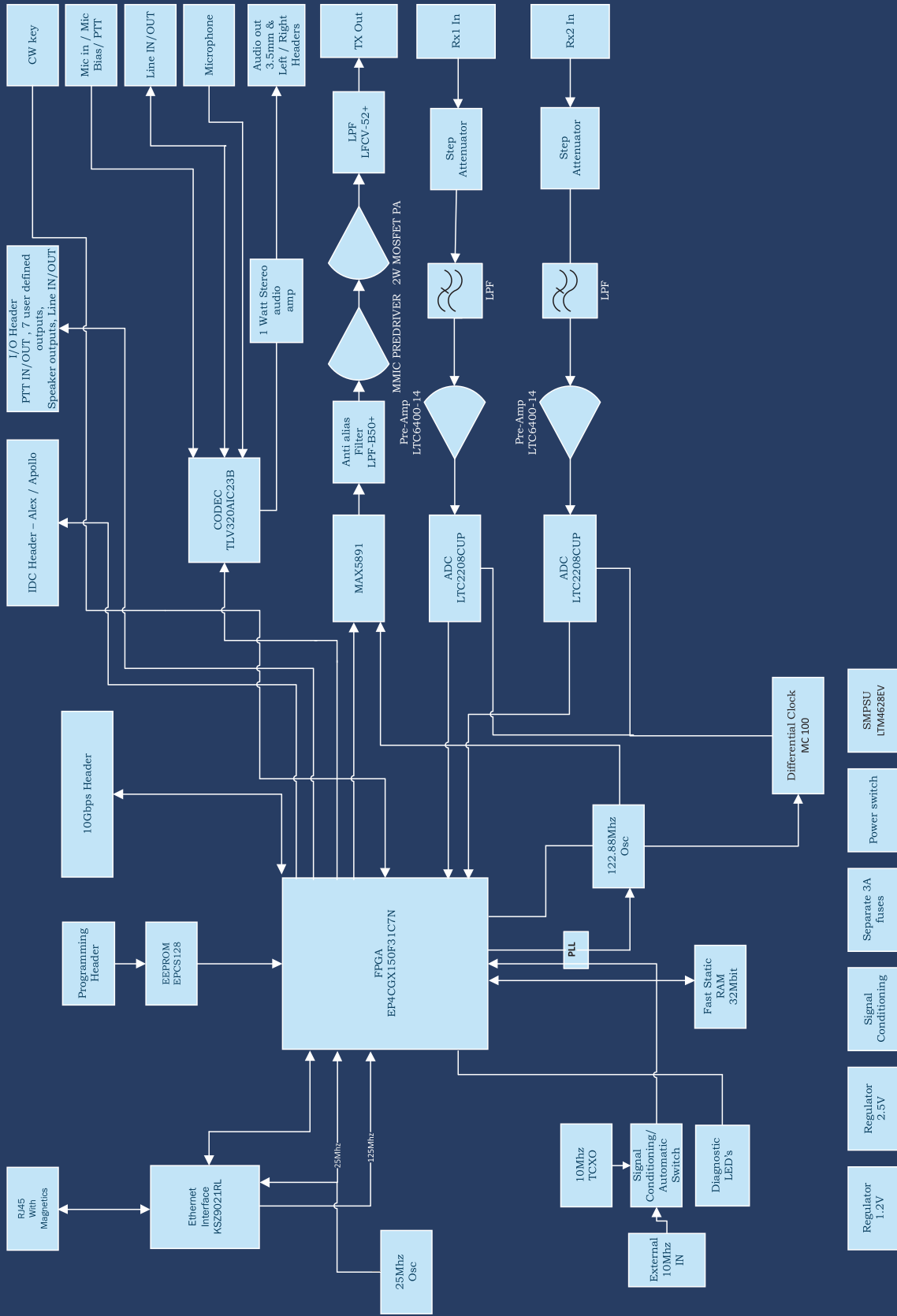

ANAN-7000LE MKII SDR CARD

Copyright 2019 – Apache Labs Pty Ltd
Based on the work of the OpenHPSDR Community

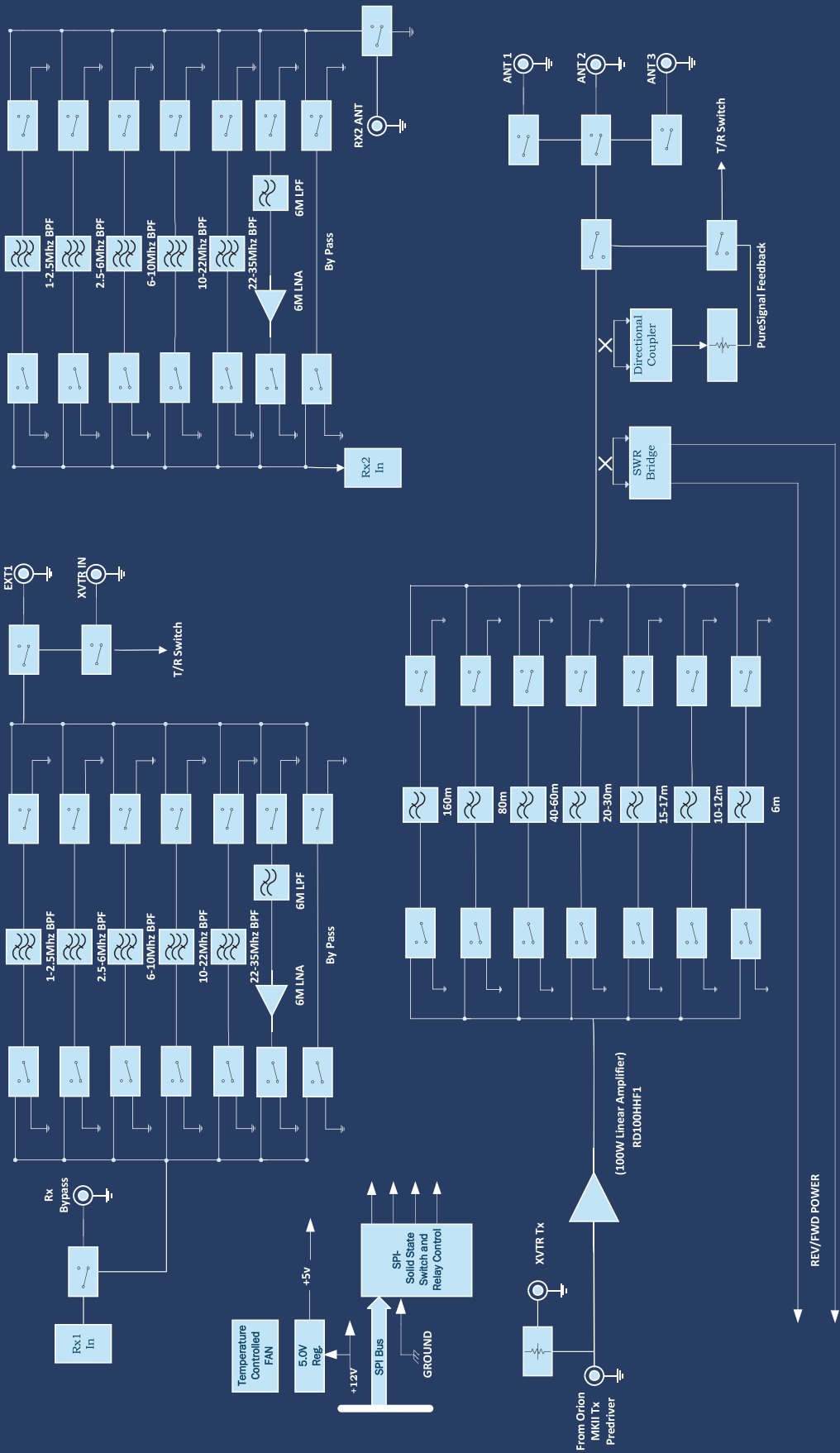

ANAN-7000LE MKII AMP & FILTERS

Copyright 2019 – Apache Labs Pty Ltd
Based on the work of the OpenHPSDR Community

SPECIFICATIONS & HIGHLIGHTS

<p>GENERAL SPECIFICATIONS:</p> <ul style="list-style-type: none"> Architecture: Direct Sampling DDC/DUC Transceiver Interface: Ethernet Phase Noise (Clock): -149dB @ 10Khz TCXO Stability (Typical): /- .1 PPM Modes: CW, SSB, NFM, AM, Digital Antenna Ports: 3 - BNC 50 ohm Software Configurable Ports, 2 - BNC ADC1 receive only antenna ports, 1 - BNC Transverter receive only port, 1 - BNC for ADC2 Frequency Resolution: 1 Hz 	<p>NOISE BLANKERS:</p> <p>The PowerSDR provides a choice of two Wideband Noise Blankers in addition to the new Spectral Noise Blanker by Warren NR0V.</p> <p>The two Wideband Noise Blankers are:</p> <ul style="list-style-type: none"> A pre-emptive Blanker which effectively slews it's output to zero before an impulse arrives, and then slews back to full amplitude after the impulse passes. An Interpolating Noise Blanker which is also pre-emptive, but has modes such as Linear interpolation of the signal during the impulse. Wideband Noise Blankers, while they are the best choice in some situations, have a well-known issue that they may become ineffective in the presence of strong adjacent signals, for example during a busy contest. The Spectral Noise Blanker cleverly overcomes this deficiency by using Linear Predictive Coding (LPC). LPC provides the capability to predict a sequence of samples by analyzing the spectral content of the samples before and after the sequence. By comparing the predictions with the measured samples, impulses are detected and blanked or reduced. The LPC is again used to predict what the signal waveform should be during the incident pulse and thereby replace the corrupt samples with clean signals.
<p>ELECTRICAL SPECIFICATIONS:</p> <ul style="list-style-type: none"> 13.8v DC @ 25A, 3A Rx/25A Tx (13.8v 30A Supply recommended) 	<p>NOISE REDUCTION:</p> <p>Two types of Noise Reduction algorithms are provided to minimize random noise. The first is a special implementation of a Least Mean Square (LMS) algorithm and the second is a new Spectral Noise Reduction NR2 (2015). LMS algorithms are used in most Software Defined Radio's and Digital Signal Processing modules due to their relatively simple implementation and low compute requirements. However they use only the input signal as a reference to identify the output and therefore are unable to achieve optimal signal-to-noise ratios and they sometimes yield an unusual "in the barrel" or "underwater" sound. The new Spectral Noise Blanker specifically uses sophisticated statistical models of speech and noise to produce superior signal-to-noise ratios and vibrant sound output.</p>
<p>MECHANICAL SPECIFICATIONS:</p> <ul style="list-style-type: none"> 10Kg (approx. Weight) Dimensions: 384MM (L) x 114MM (H) x 310MM (W) (Not including extrusions) Rugged Steel Chassis 	<p>MINIMIZED LATENCY:</p>
<p>RECEIVER SPECIFICATIONS:</p> <ul style="list-style-type: none"> Receiver Architecture: Direct Down Conversion Dual 16 bit Phase Synchronous ADCs Independent filter banks for each ADC 6M LNAs Frequency Coverage: 9Khz to 60Mhz Attenuator: 1-30dB step attenuator Reciprocal Mixing Dynamic Range (RMDR): 116dB @ 2Khz offset Receiver Phase noise: -149dB @ 10Khz Image rejection: 90dB Hardware support for 7 independent receivers assignable to either ADC 	<p>In Software Defined Radio's, filtering usually contributes the most latency. There are two reasons; (1) large sets of samples, "buffers", are normally collected before executing the filters so that efficient FFT algorithms can be used, and (2) sharp "brick-wall" linear-phase filters inherently have long latency, no matter how cleverly they are implemented. Both these issues have been addressed and conquered in the ANAN-7000DLE Transceiver. Small "buffers", requiring little collection time, can now be used even while retaining the very sharp "brick-wall" filters. In addition, the option of using very low-latency "minimum-phase" filters is provided. In almost all situations, laboratory and on-air testing have demonstrated no discernible difference in performance between linear-phase and minimum-phase filters. With filters as sharp as you desire, sub-20ms receive latencies are now possible, compared to the best of conventional DSP radio's and must better than competing Software Defined Radio's.</p>
<p>TRANSMITTER SPECIFICATIONS:</p> <ul style="list-style-type: none"> Transmitter Architecture: Direct Up Conversion DAC Resolution: 16 bit RF Output Power: 100W SSB, CW, FM, RTTY, Digital; 1-30W AM IMD3 typically -68dB below PEP @ 100W output on 20M Harmonics: Typically better than -43dBc on HF and -60dBc on 6M Carrier and Opposite Sideband Suppression: Better than -80dBc Transverter IF Output: 0db to 15dB 	<p>PURE SIGNAL PRE-DISTORTION:</p>
<p>ADDITIONAL IO CONNECTIONS:</p> <ul style="list-style-type: none"> RCA - Line In, PTT In, PTT Out, 2 - DIG inputs DB9F - 7 Software Configurable Open Collector Outputs SMA - XVTR output, 10Mhz Reference Input 3.25mm Barrel Mic, CW Key, Headphones and two 6.25mm Speaker Outputs, SDR RJ-45 	<p>There is no truly Linear RF amplifier. The Non-linearity in an amplifier shows up as Intermodulation Distortion (IMD) within and outside the transmitted bandwidth. There are many challenges to reduce IMD, hence, most manufacturers of Amateur Radio Equipment do not specify their IMD, or use inefficient Class-A options that lower IMD at the expense of power. The ANAN- 7000DLE MKII was designed with the unique PureSignal Linearization (Pre- Distortion) to achieve an astounding -68dBm IMD on 20M at full 100W output. This achievement in design is an improvement of at least 25 to 30dB or approximately 1000 times lower distortion than conventional "Class-A" capable flagship transceivers.</p>
<p>ETHERNET COMMAND AND CONTROL:</p> <p>The ANAN Transceivers use a Gigabit Ethernet interface to connect to your LAN. Ethernet command and control features huge bandwidth, better noise isolation from the PC, and networked radios with remote access. Beta testers report good performance across 802.11n WiFi links.</p>	
<p>TWO PHASE SYNCHRONOUS ADCs</p> <p>ANAN-7000DLE includes phase synchronous ADC's to enable Diversity reception and other advanced applications. The Transmit chain is designed keeping in mind the unique "PureSignal" Linearization and predistortion.</p>	

Specifications subject to change, copyright 2019 - Apache Labs Pty Ltd.



20 Eva Avenue, Point Cook, VIC, 3030. Australia
 Tel: +61 459 618 933,
 Email: support@apache-labs.com,
 www.apache-labs.com